

A Story of Units[®]

Eureka Math[™]

Grade K, Module 2

Student File_A

*Contains copy-ready classwork and homework
as well as templates (including cut outs)*

Published by the non-profit Great Minds.

Copyright © 2015 Great Minds. All rights reserved. No part of this work may be reproduced or used in any form or by any means — graphic, electronic, or mechanical, including photocopying or information storage and retrieval systems — without written permission from the copyright holder. “Great Minds” and “Eureka Math” are registered trademarks of Great Minds.

Printed in the U.S.A.

This book may be purchased from the publisher at eureka-math.org

10 9 8 7 6 5 4 3 2 1

Name _____

Date _____

Sort the shapes.

Shapes with a Curve

Shapes without a Curve

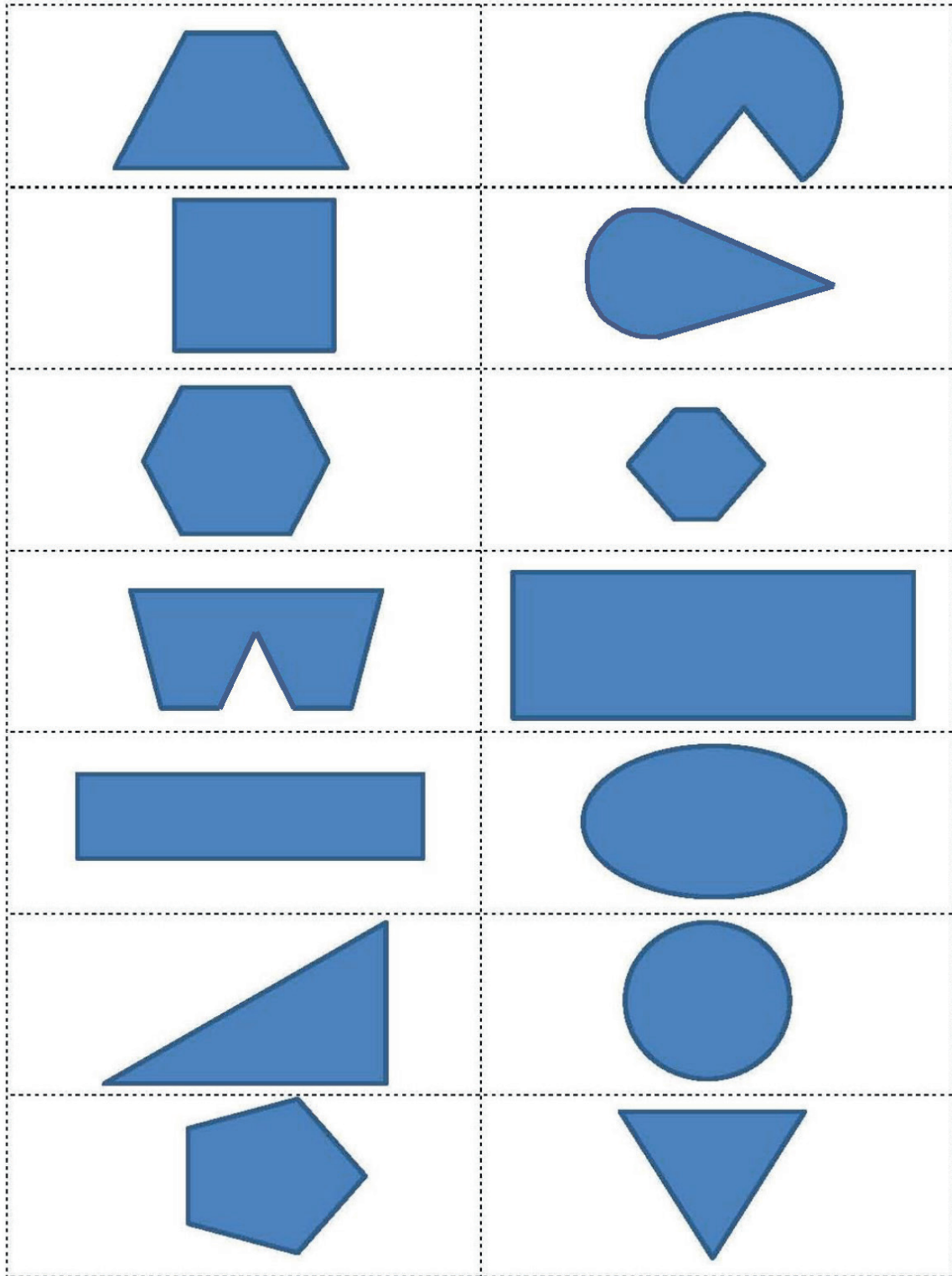

Name _____

Date _____

Draw a line from the shape to its matching object.

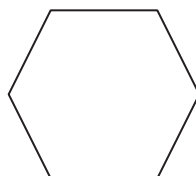
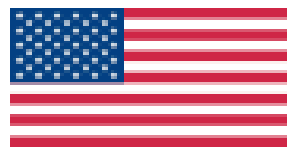
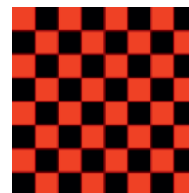
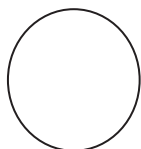

Name _____

Date _____

Find the triangles, and color them blue. Put an X on shapes that are not triangles.

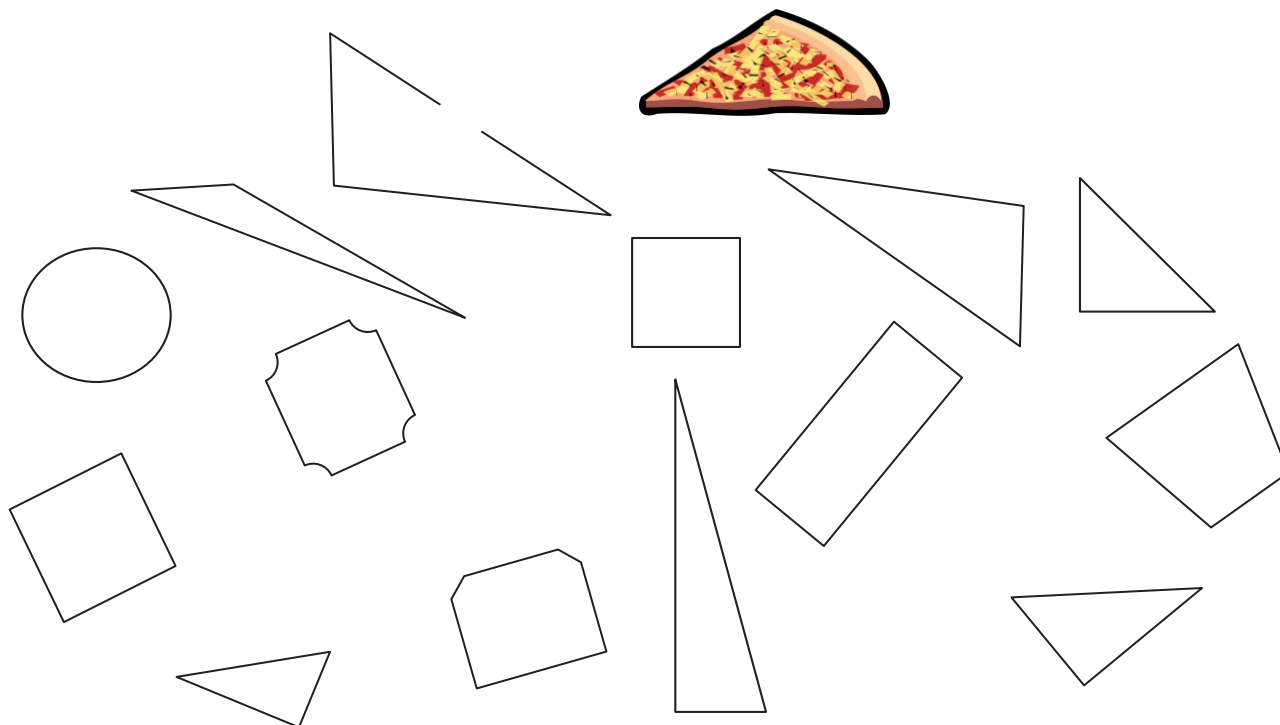

Draw some triangles.

Name _____

Date _____

Color the triangles red and the other shapes blue.

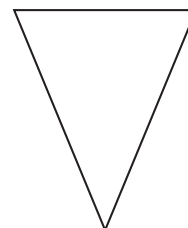
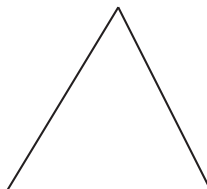
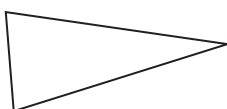
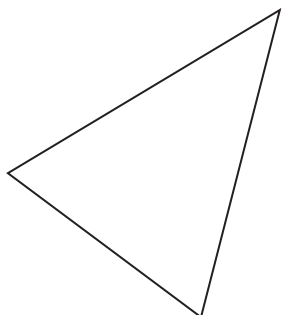
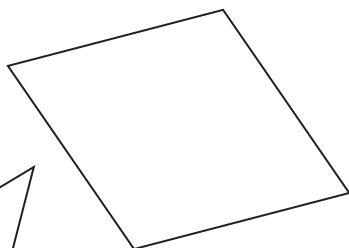
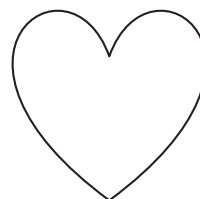
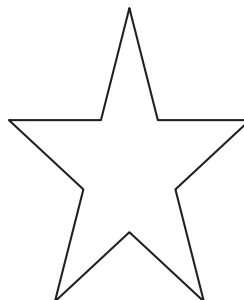
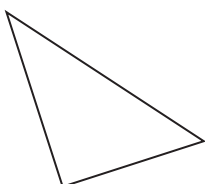
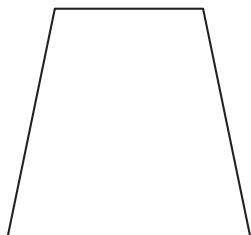

Draw 2 different triangles of your own.

Name _____

Date _____

Find the rectangles, and color them red. Put an X on shapes that are not rectangles.

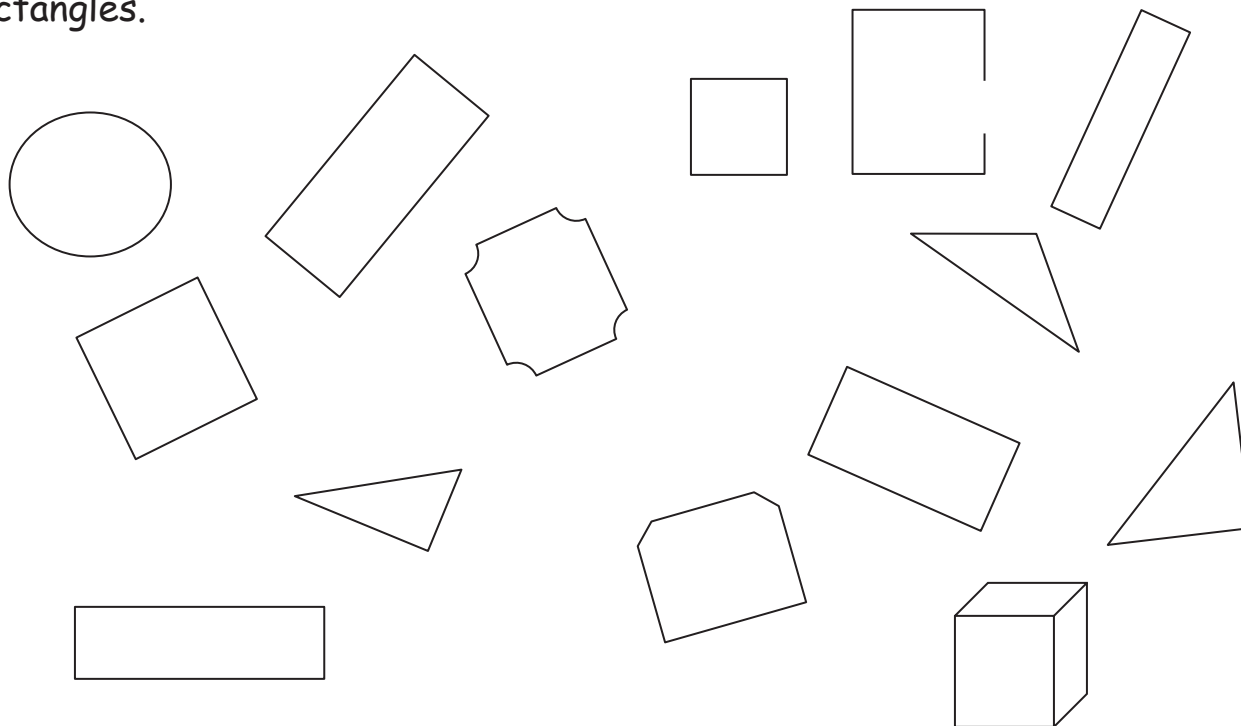

Draw some rectangles.

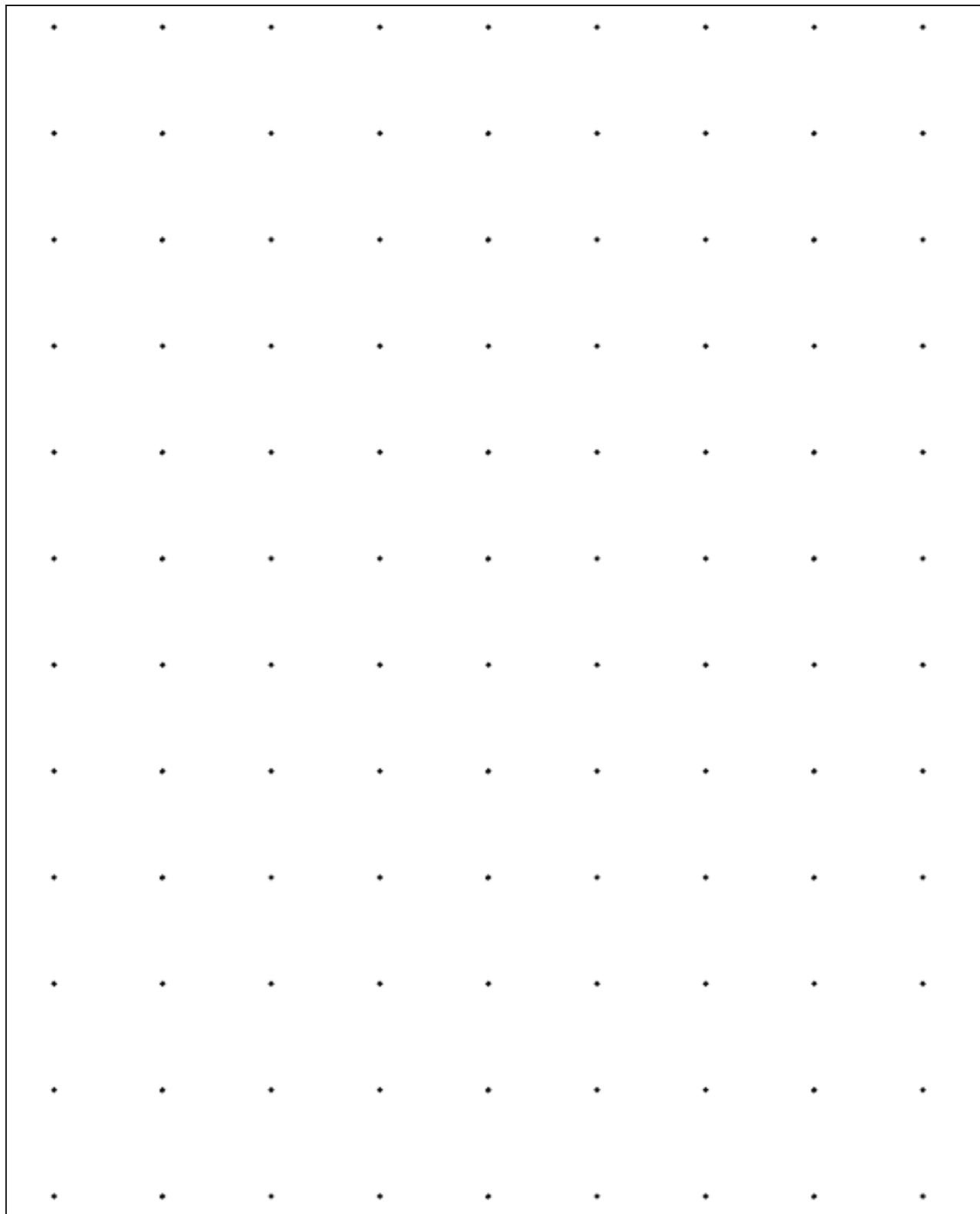

dot paper

Name _____

Date _____

Find the circles, and color them green. Find the hexagons, and color them yellow. Put an X on shapes that are not hexagons or circles.

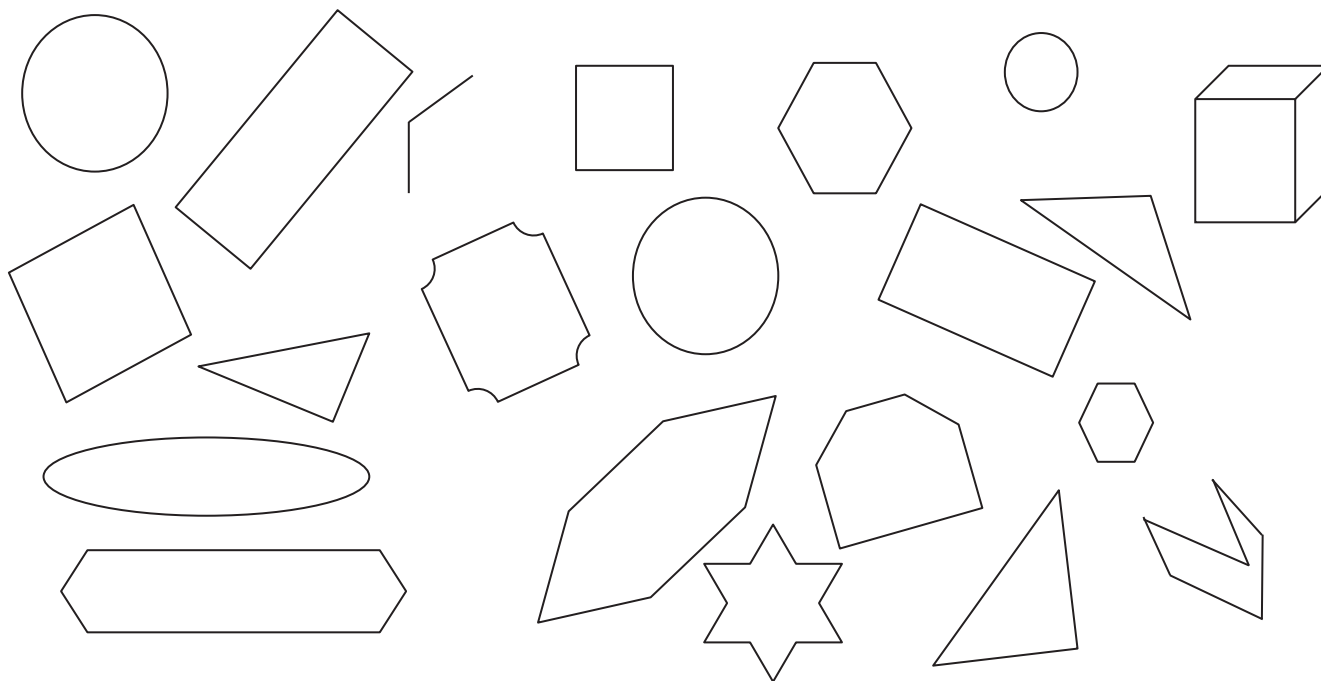

Draw hexagons and circles.

Name _____ Date _____

Color the triangles blue.

Color the rectangles red.

Color the circles green.

Color the hexagons yellow.

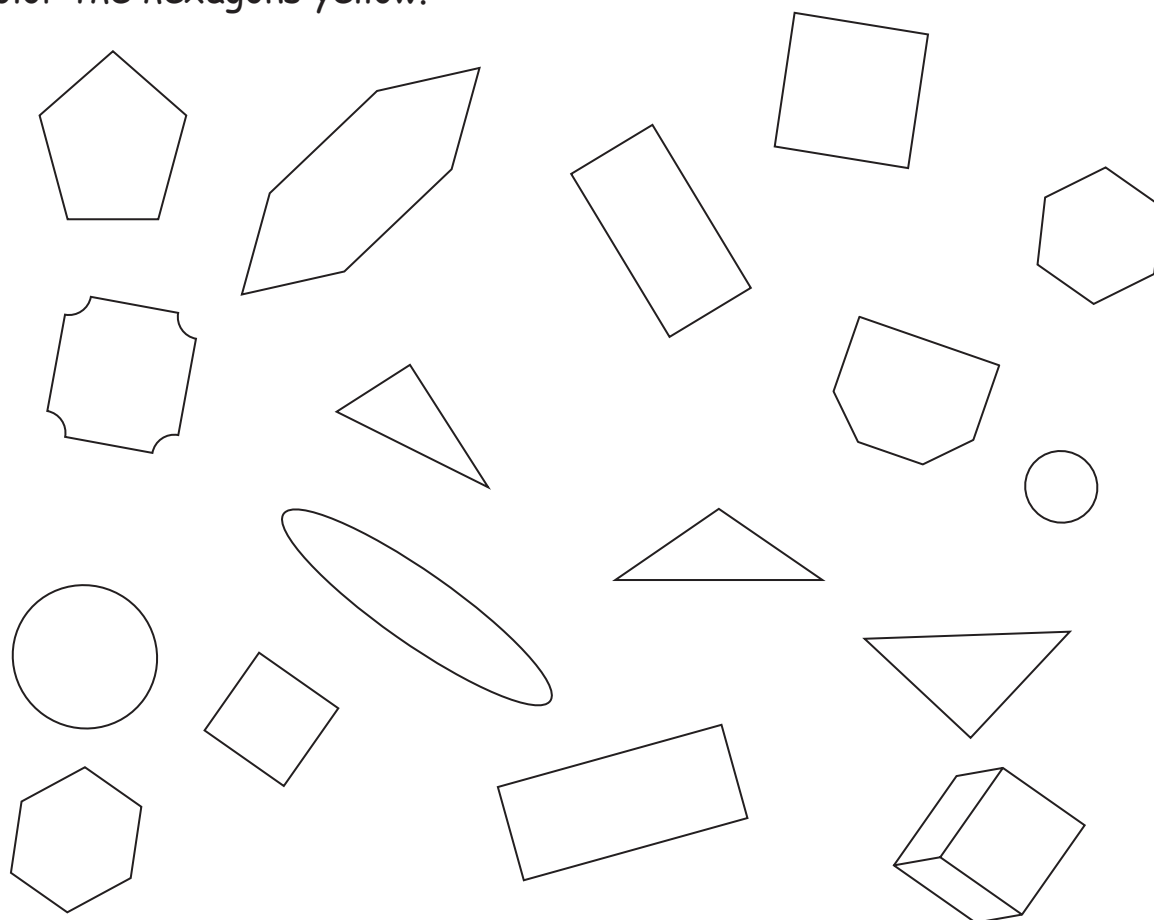

On the back of your paper, draw 2 triangles and 1 hexagon.

How many shapes did you draw? _____

Name _____

Date _____

Cut out all of the shapes, and put them next to your paper with the duck.
Listen to the directions, and glue the objects onto your paper.

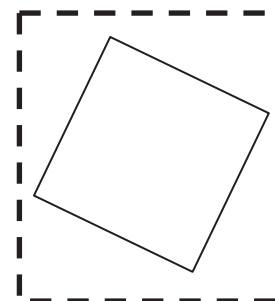
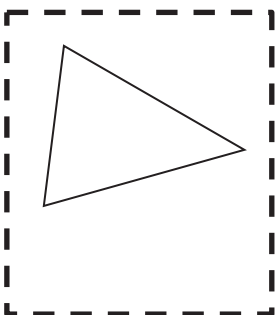
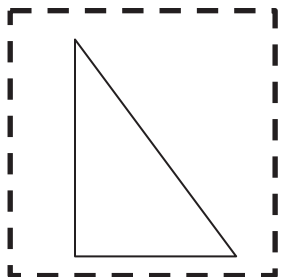
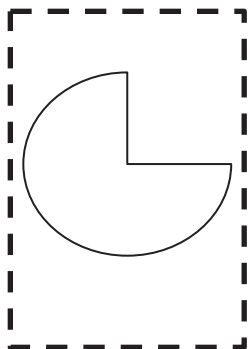
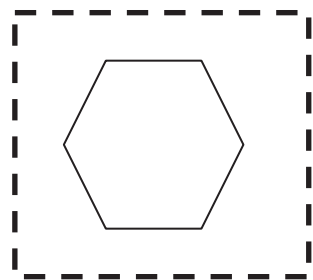
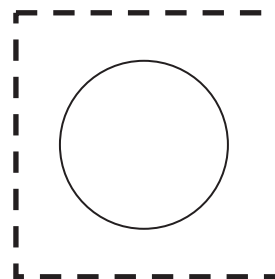
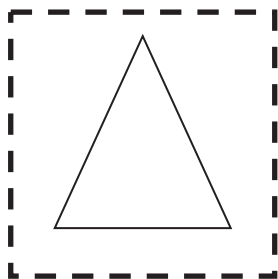
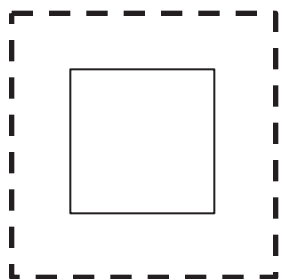

Name _____

Date _____



Name _____

Date _____

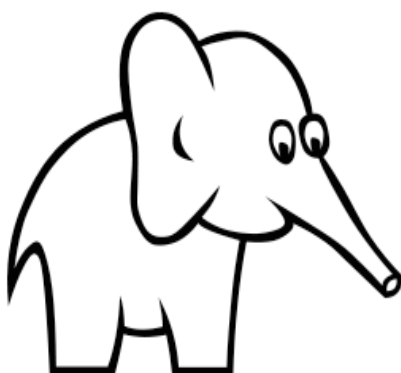

- **Behind** the elephant, draw a shape with 4 straight sides that are exactly the same length. Color it blue.
- **Above** the elephant, draw a shape with no corners. Color it yellow.
- **In front of** the elephant, draw a shape with 3 straight sides. Color it green.
- **Below** the elephant, draw a shape with 4 sides, 2 long and 2 short. Color it red.
- **Below** the elephant, draw a shape with 6 corners. Color it orange.

On the back of your paper, draw 1 hexagon and 4 triangles.
How many shapes did you draw? Put your answer in the circle.

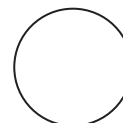

Name _____

Date _____

Match these objects and solids by drawing a line with your ruler from the object to the solid.

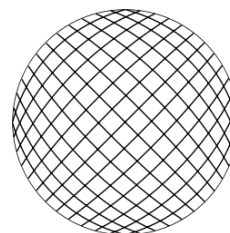
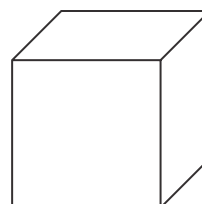
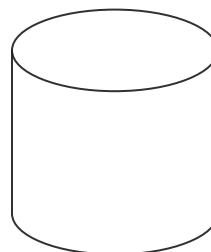

On the back of the paper, draw solid shapes that you see in the classroom.

Name _____

Date _____

Find things in your house or in a magazine that look like these solids. Draw the solids or cut out and paste pictures from a magazine.

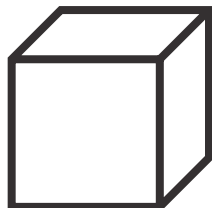
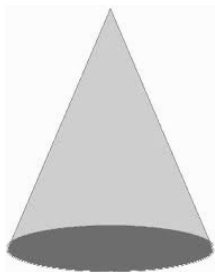
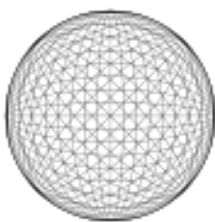
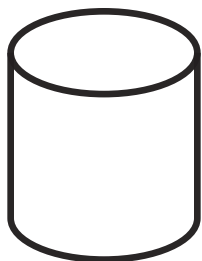

Name _____

Date _____

Circle the cylinders with red.

Circle the cubes with yellow.

Circle the cones with green.

Circle the spheres with blue.

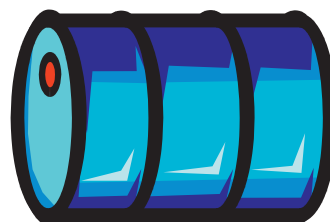

Name _____

Date _____

Cut one set of solid shapes. Sort the 4 solid shapes. Paste onto the chart.

These have corners.

These do not have corners.

--	--

Cut the other set of solid shapes, and make a rule for how you sorted them. Paste onto the chart.

--	--

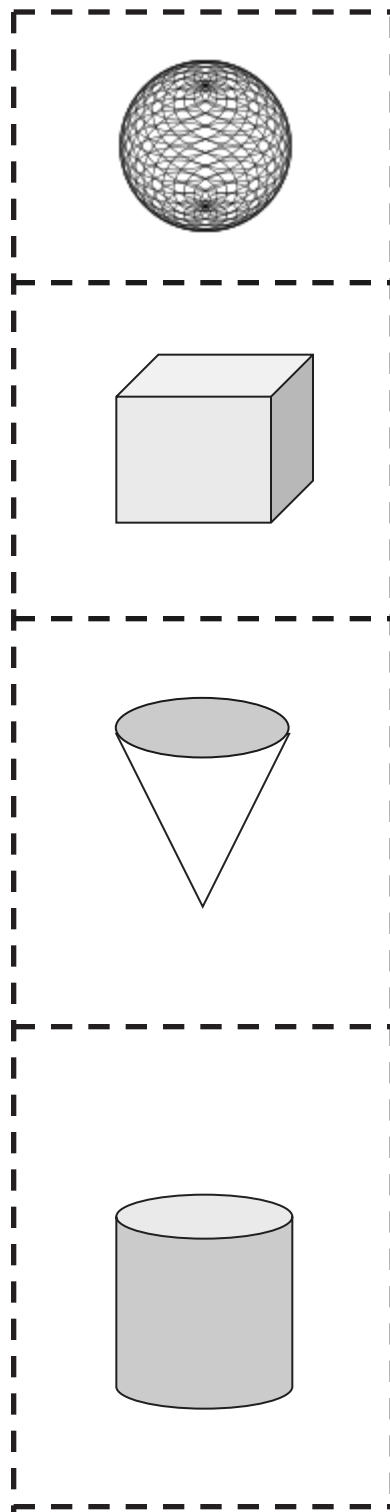
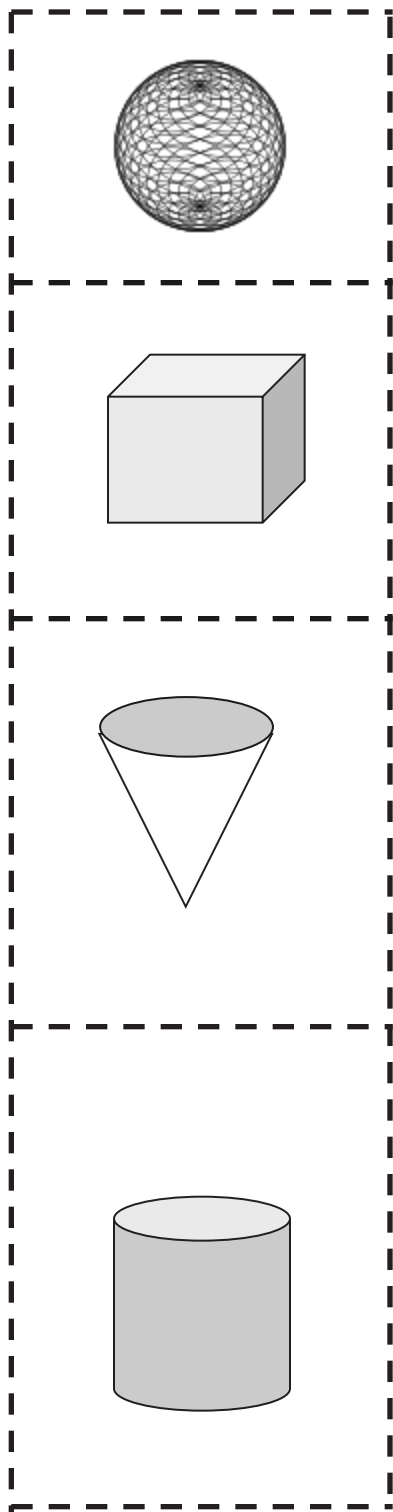

Name _____

Date _____



Directions: Read to students.

Paste the sphere **above** the train.

Paste the cube **behind** the train.

Paste the cylinder **in front of** the train.

Paste the cone **below** the train.

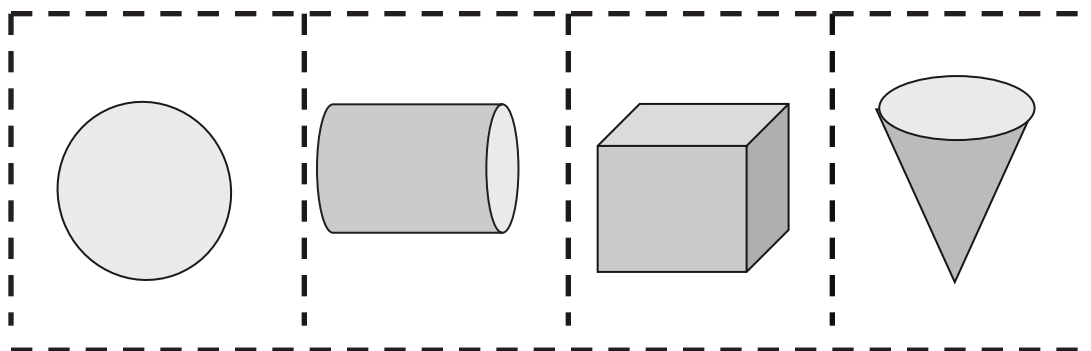

Provide one
strip for
every student.

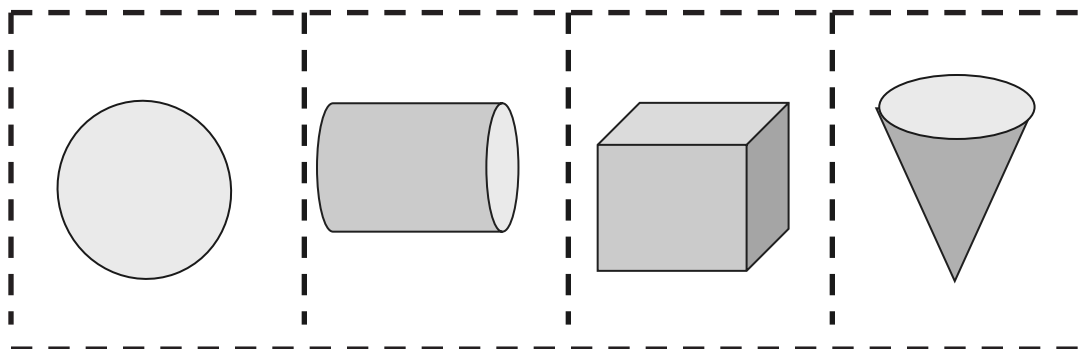
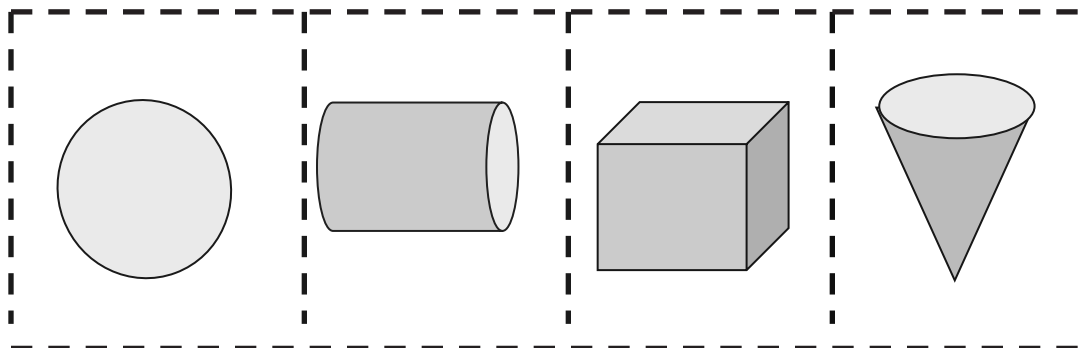

Name _____

Date _____

Tell someone at home the names of each solid shape.

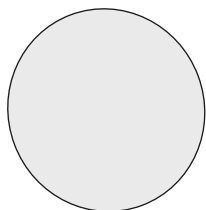

Sphere

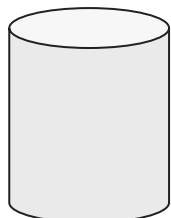

Cylinder

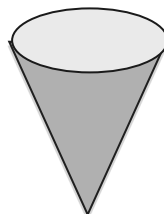

Cone

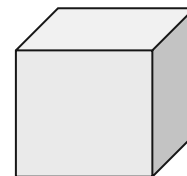

Cube



Color the car **beside** the stop sign green.

Circle the **next** car with blue.

Color the car **behind** the circled car red.

Draw a road **below** the cars.

Draw a policeman **in front of** the cars.

Draw a sun **above** the cars.

Name _____

Date _____

Circle the pictures of the flat shapes with red. Circle the pictures of the solid shapes with green.

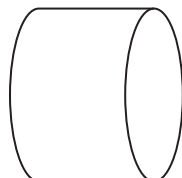
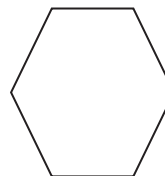
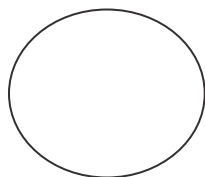
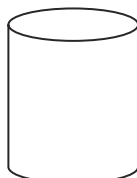
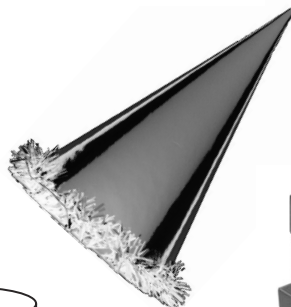
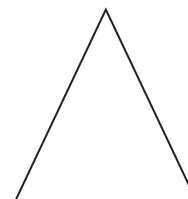
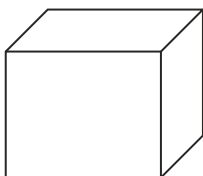
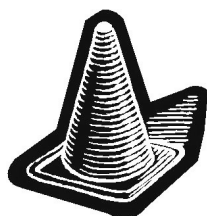

Name _____

Date _____

In each row, circle the one that doesn't belong. Explain your choice to a grown-up.

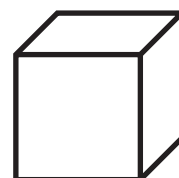
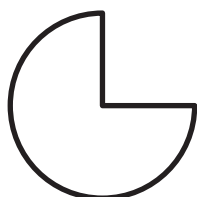
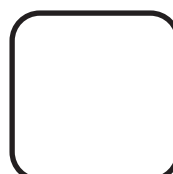
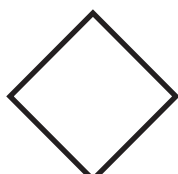
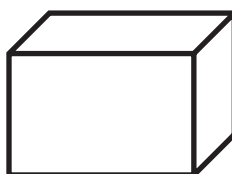
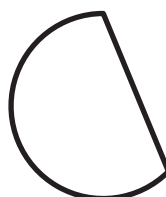
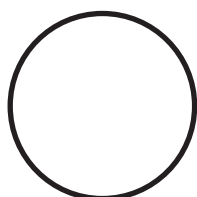
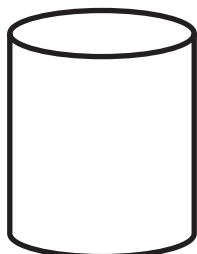
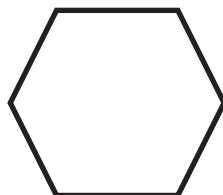
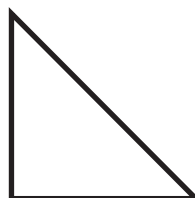
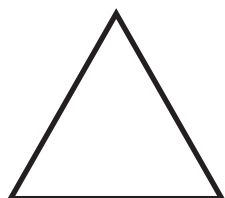
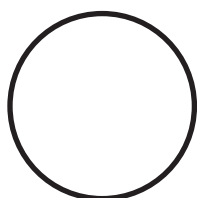

Name _____

Date _____

Shape Up Your Kitchen!

Search your kitchen to see what shapes and solids you can find. Make a kitchen-shaped collage by drawing the shapes that you see and by tracing the faces of the solids that you find. Color your collage.

Name _____

Date _____

These are (____).

These are not (____).

work mat

Cut Out Packet

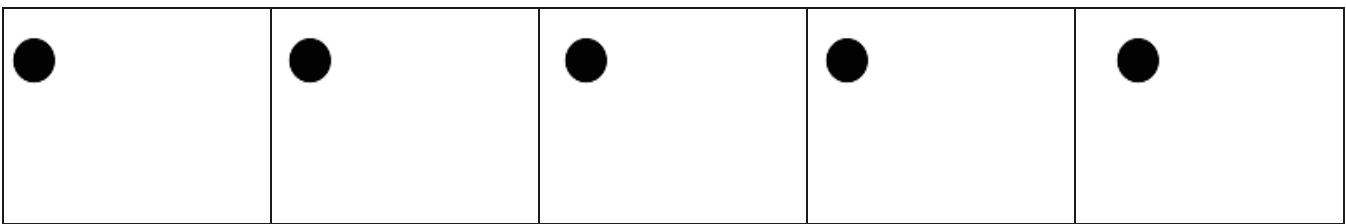
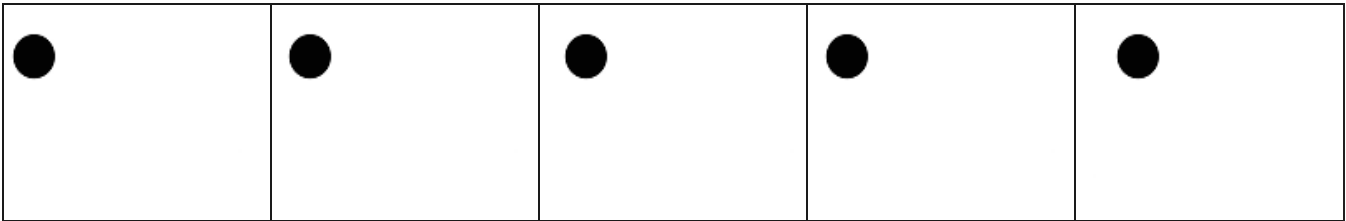
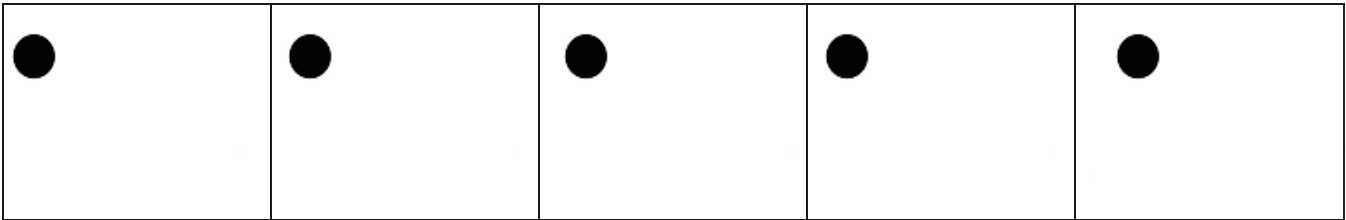
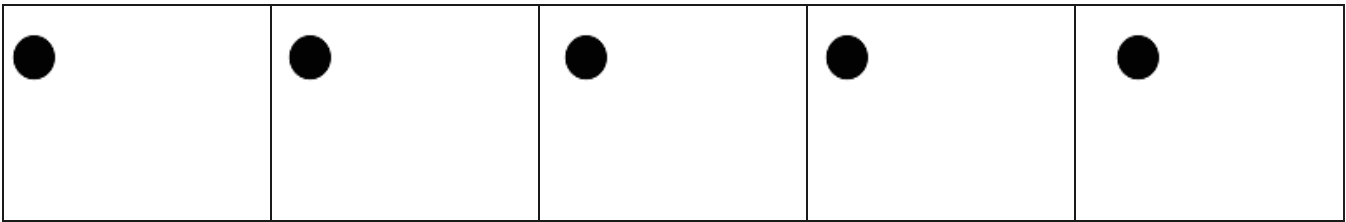
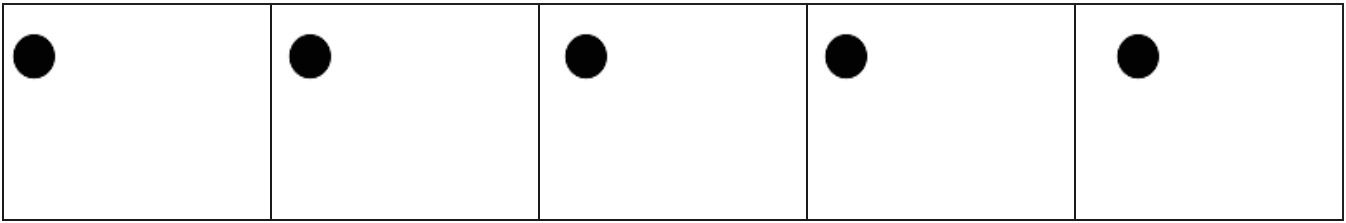

5-group mat

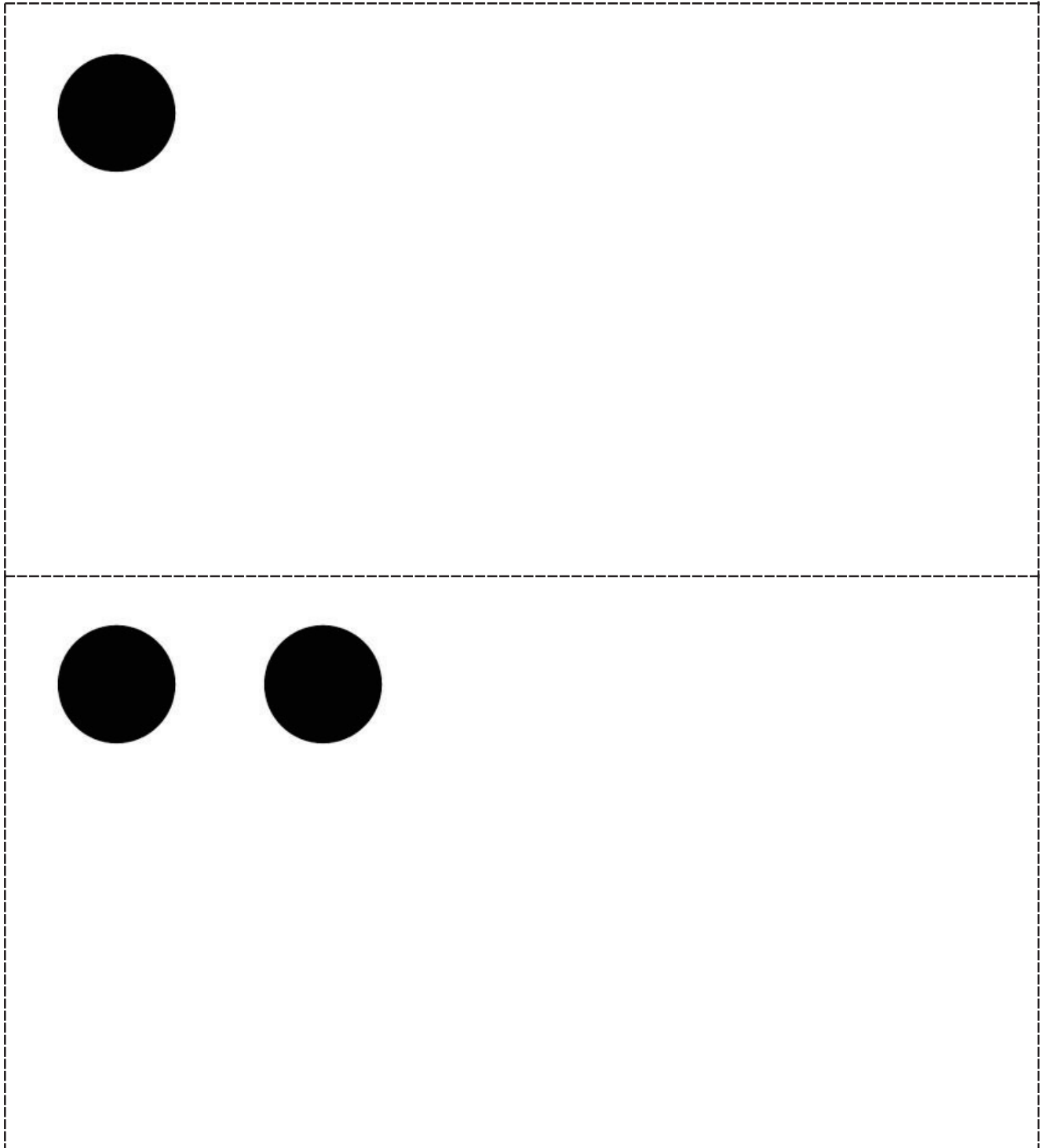

large 5-group cards (Copy on card stock, and cut. Save full set.)

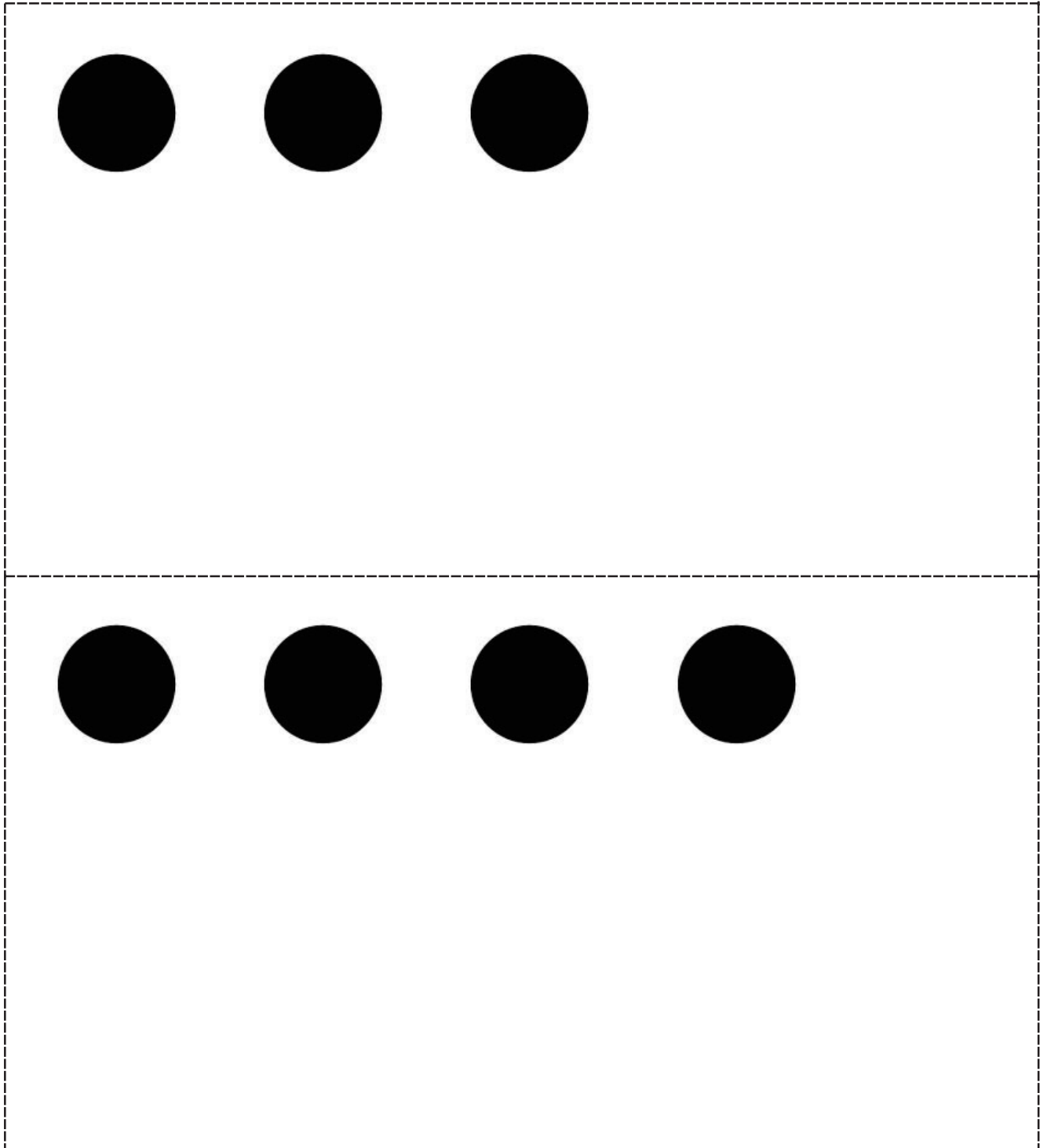

large 5-group cards (Copy on card stock, and cut. Save full set.)

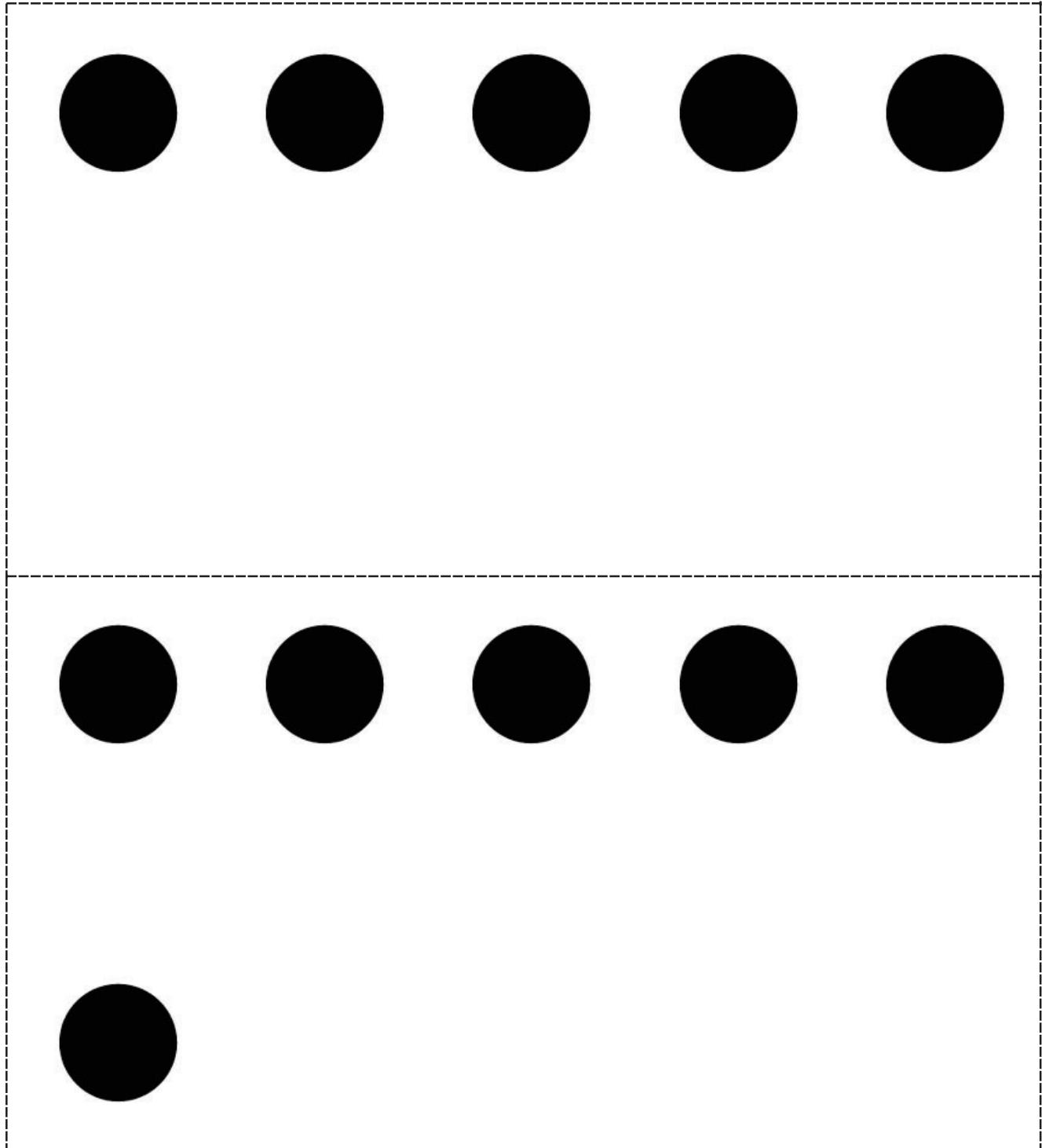

large 5-group cards (Copy on card stock, and cut. Save full set.)

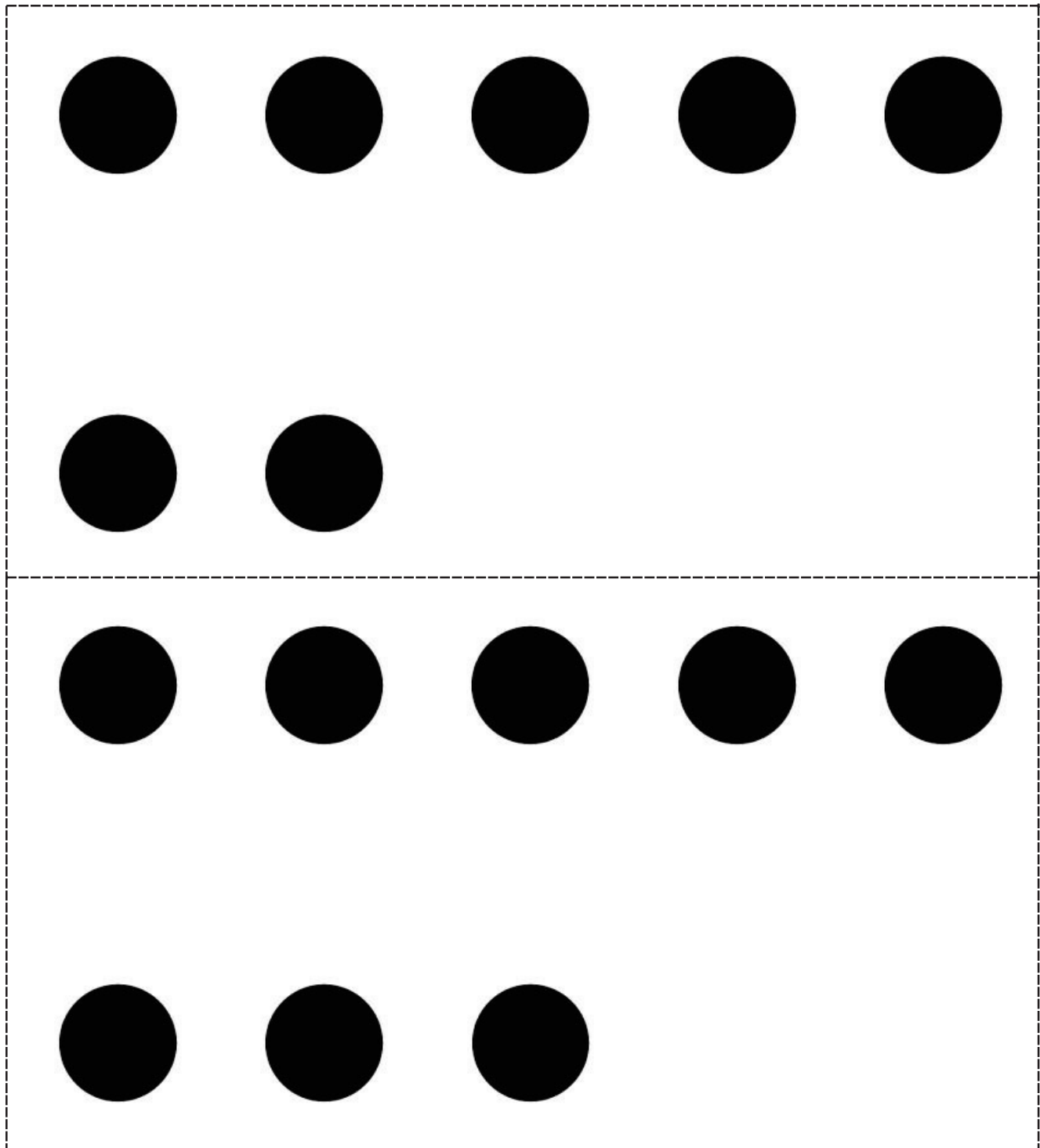

large 5-group cards (Copy on card stock, and cut. Save full set.)

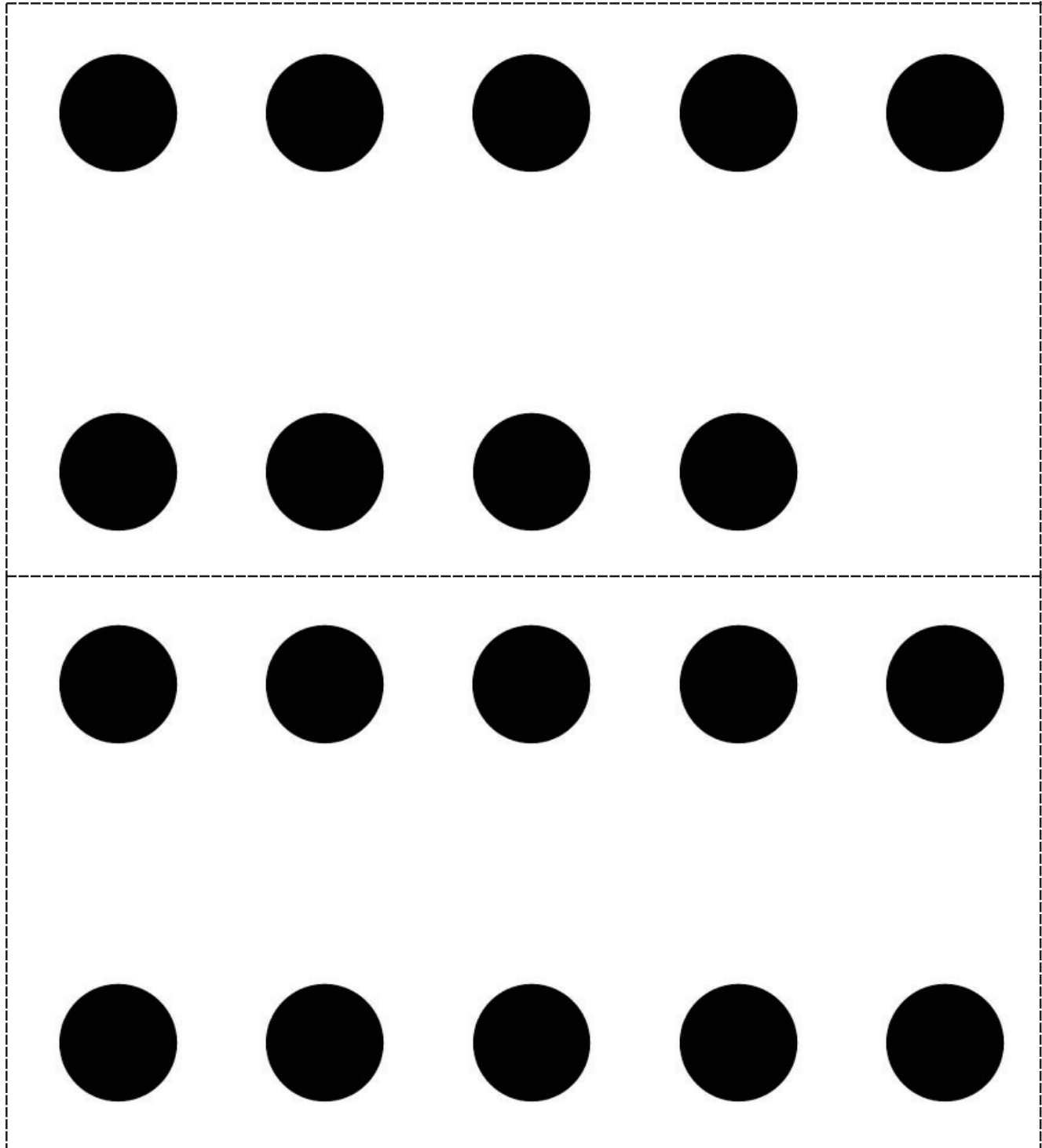

large 5-group cards (Copy on card stock, and cut. Save full set.)

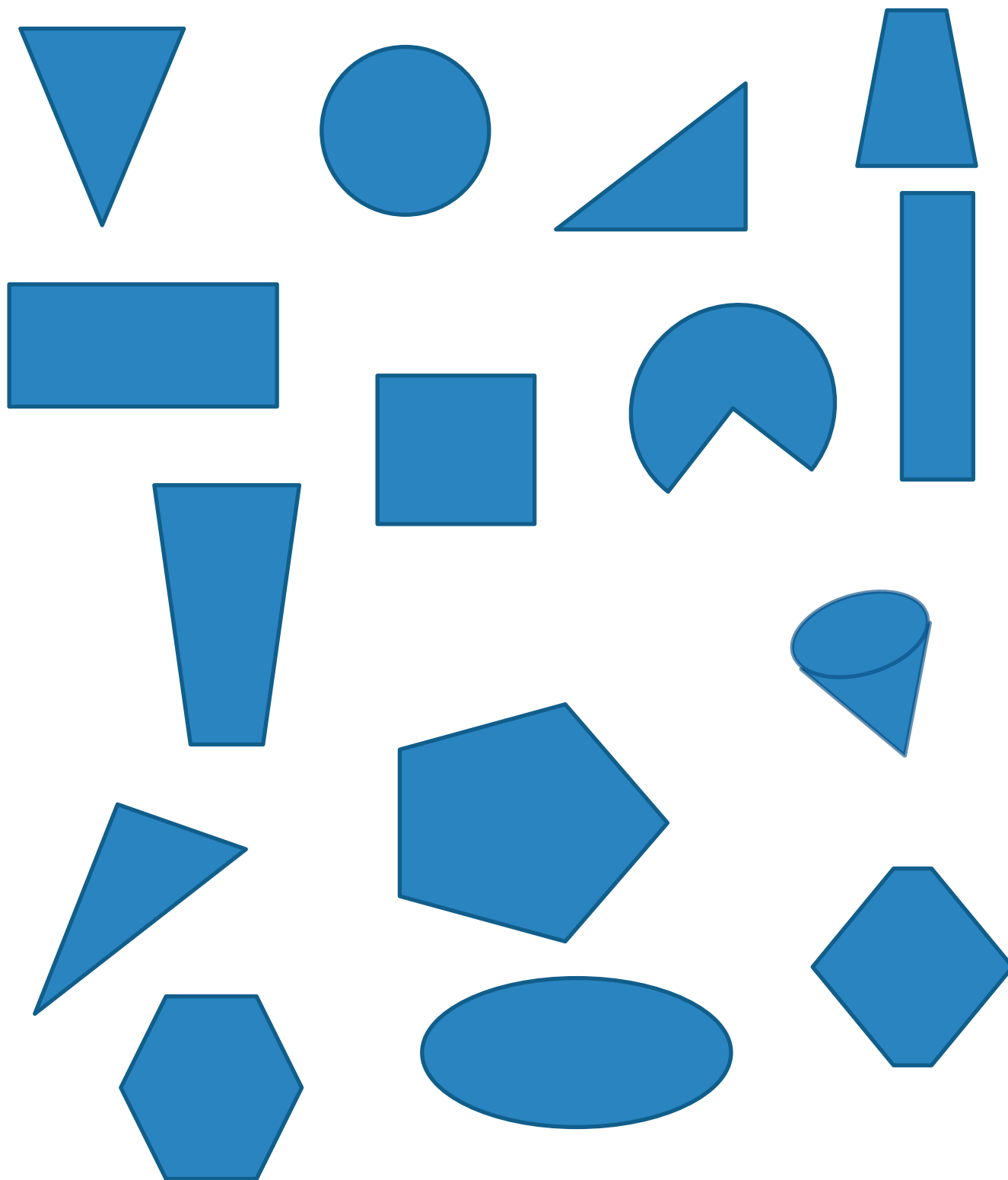

shapes

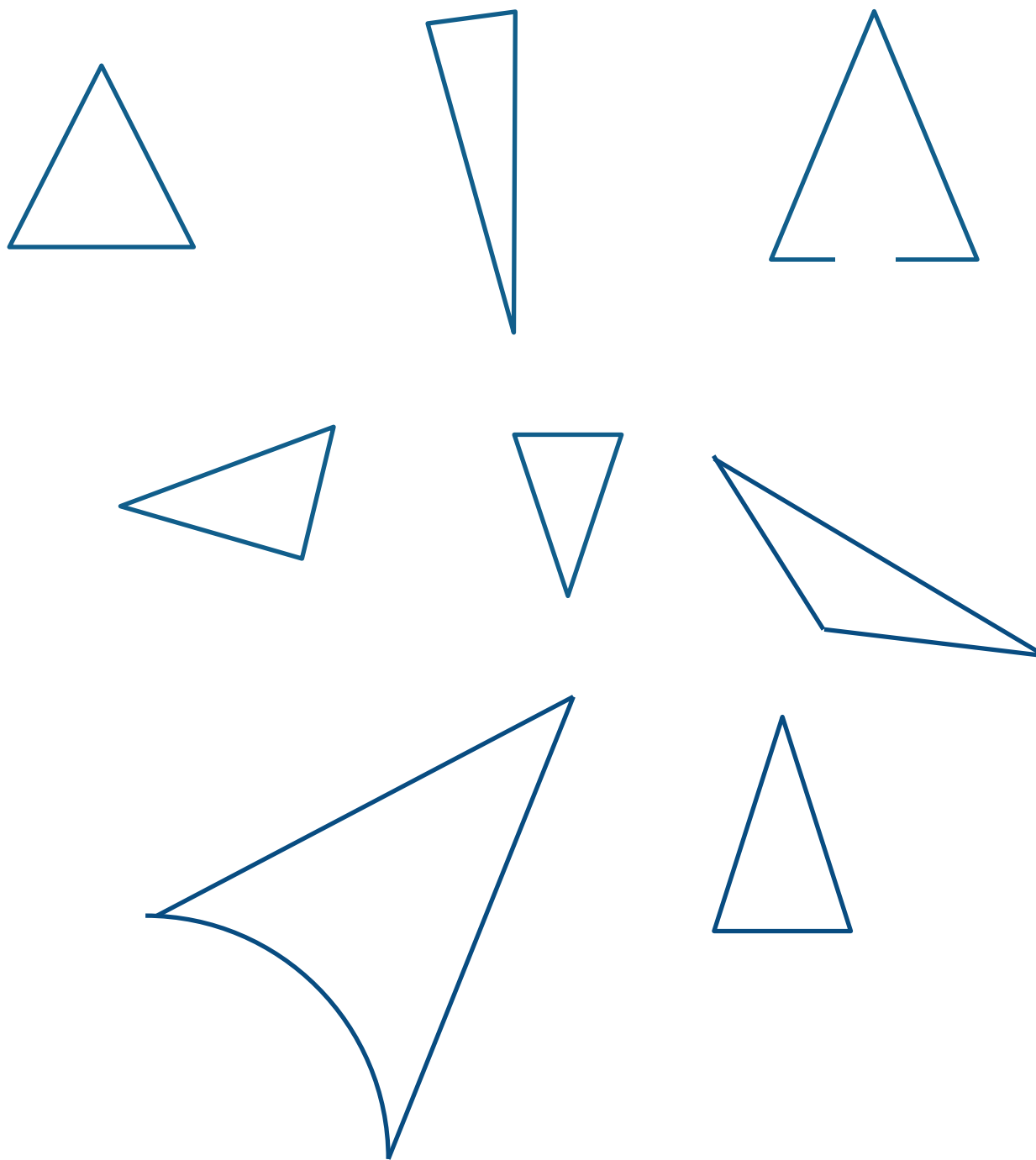

shapes

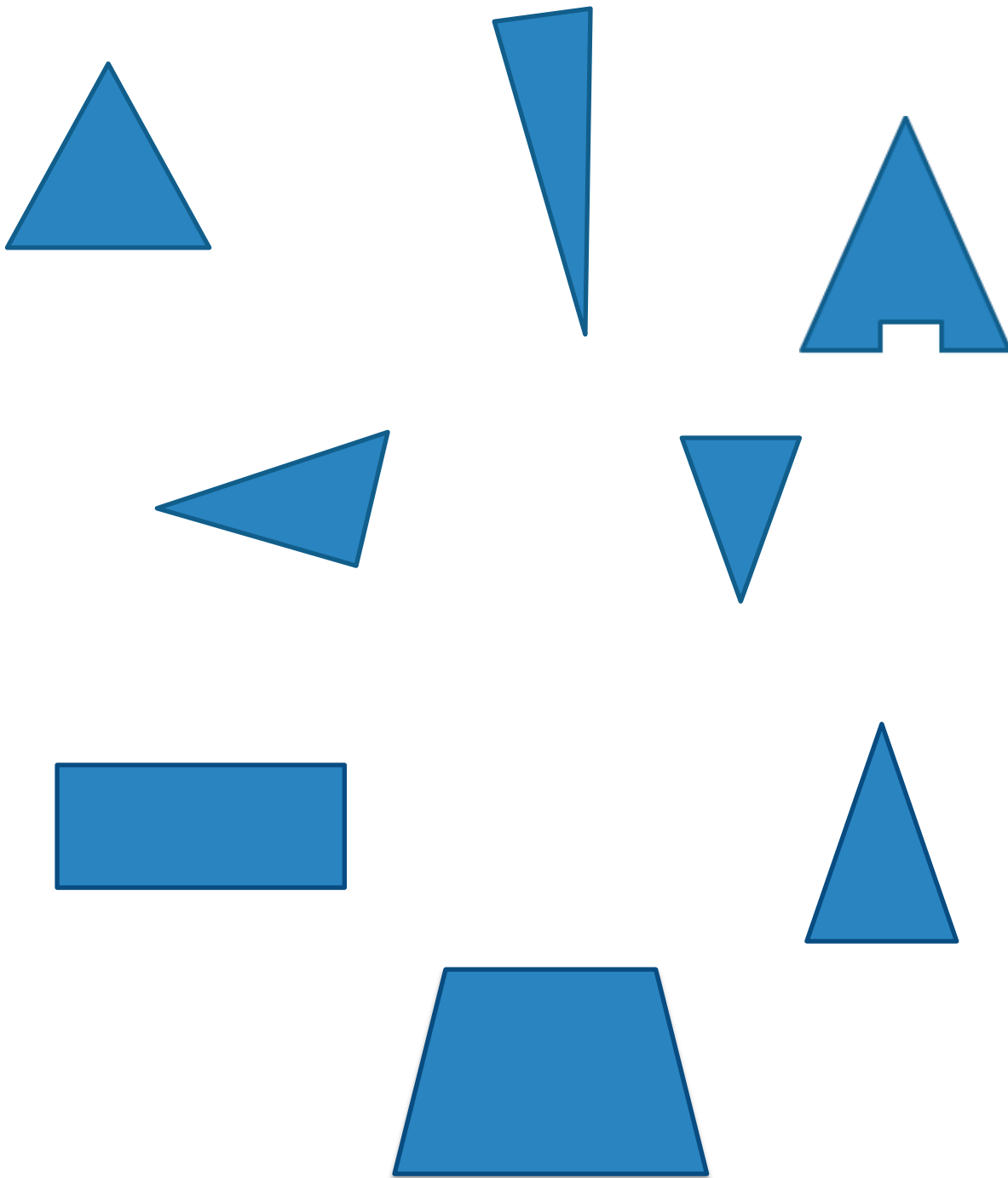

shapes

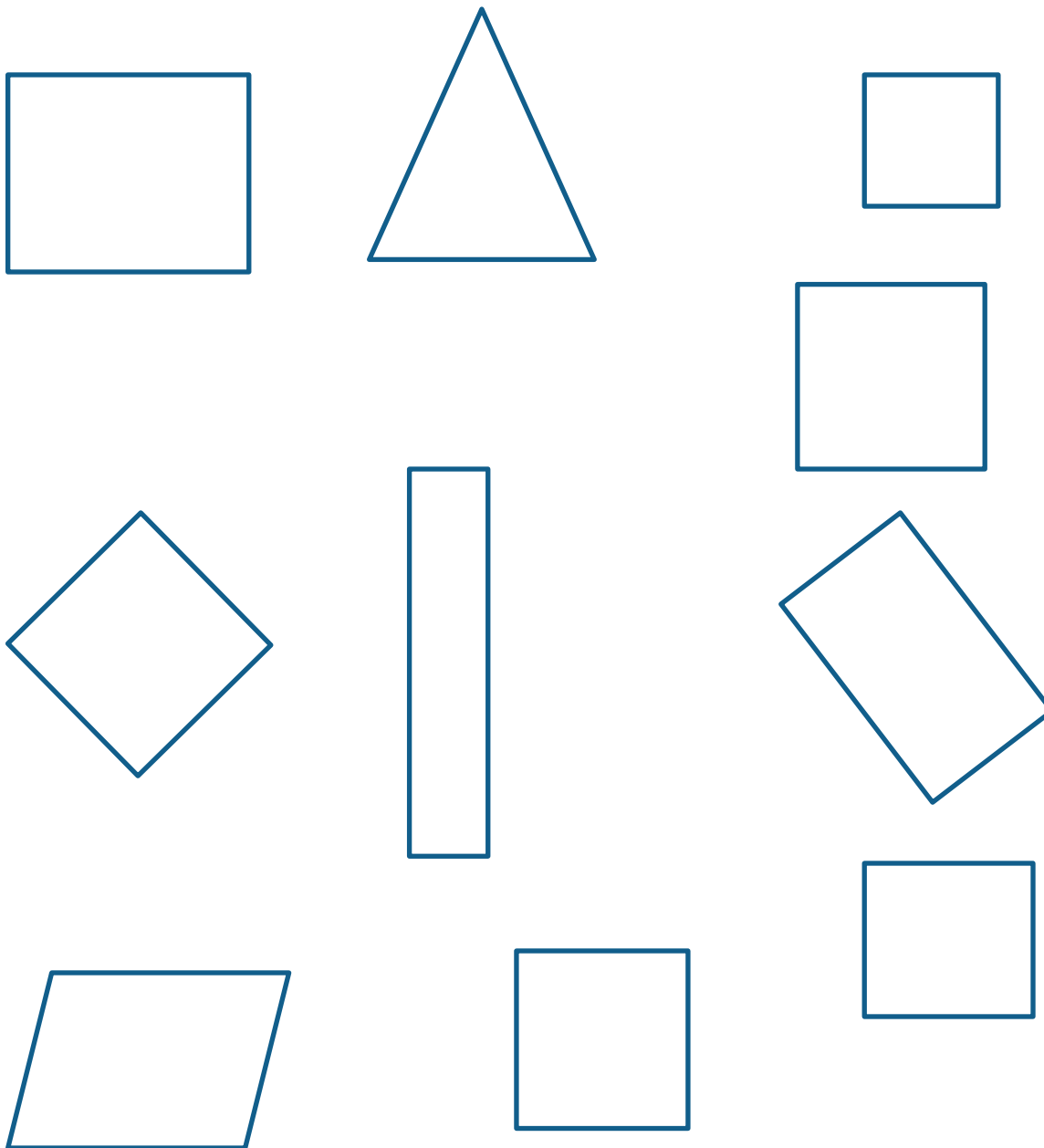

shapes

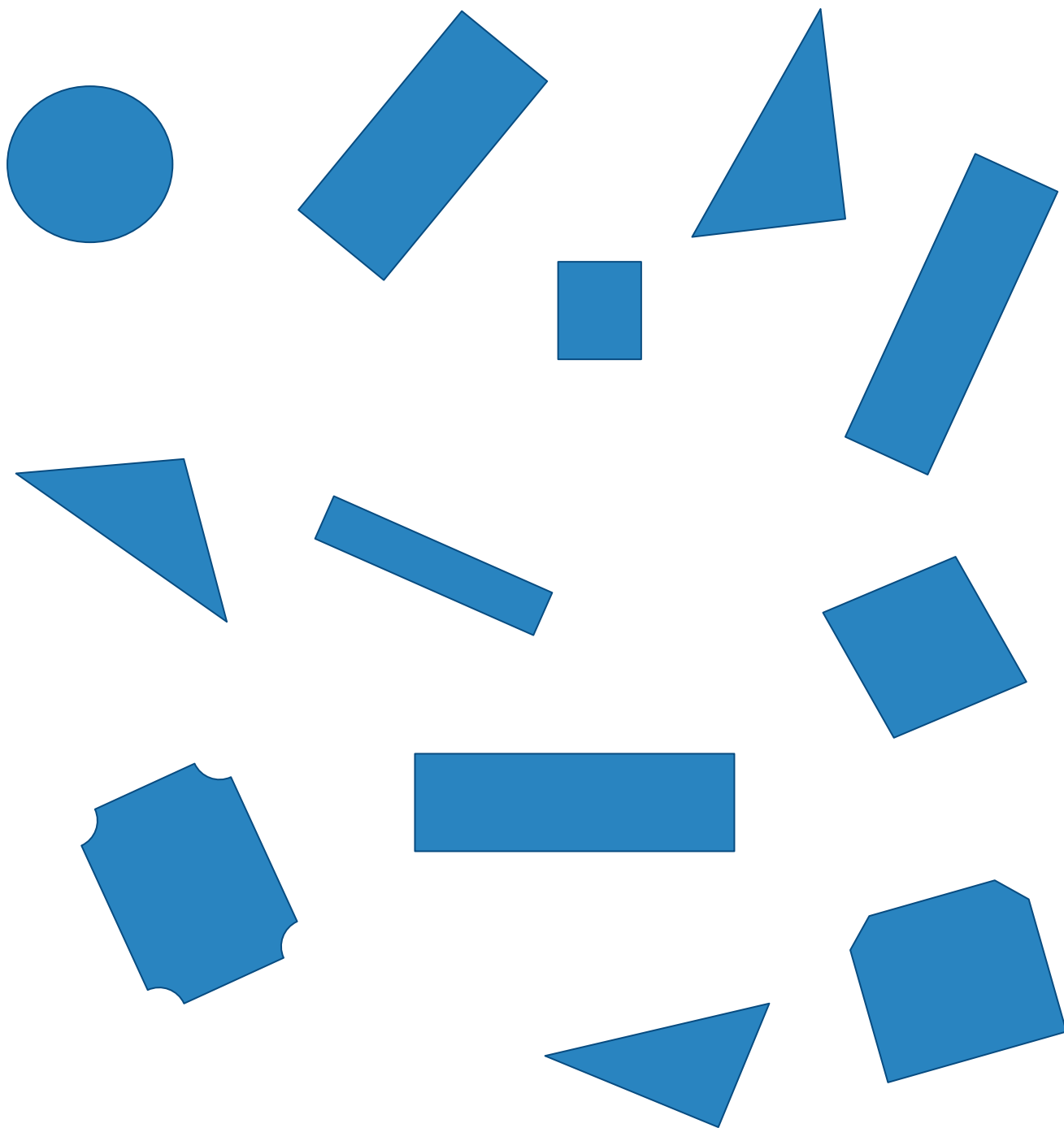

paper shapes

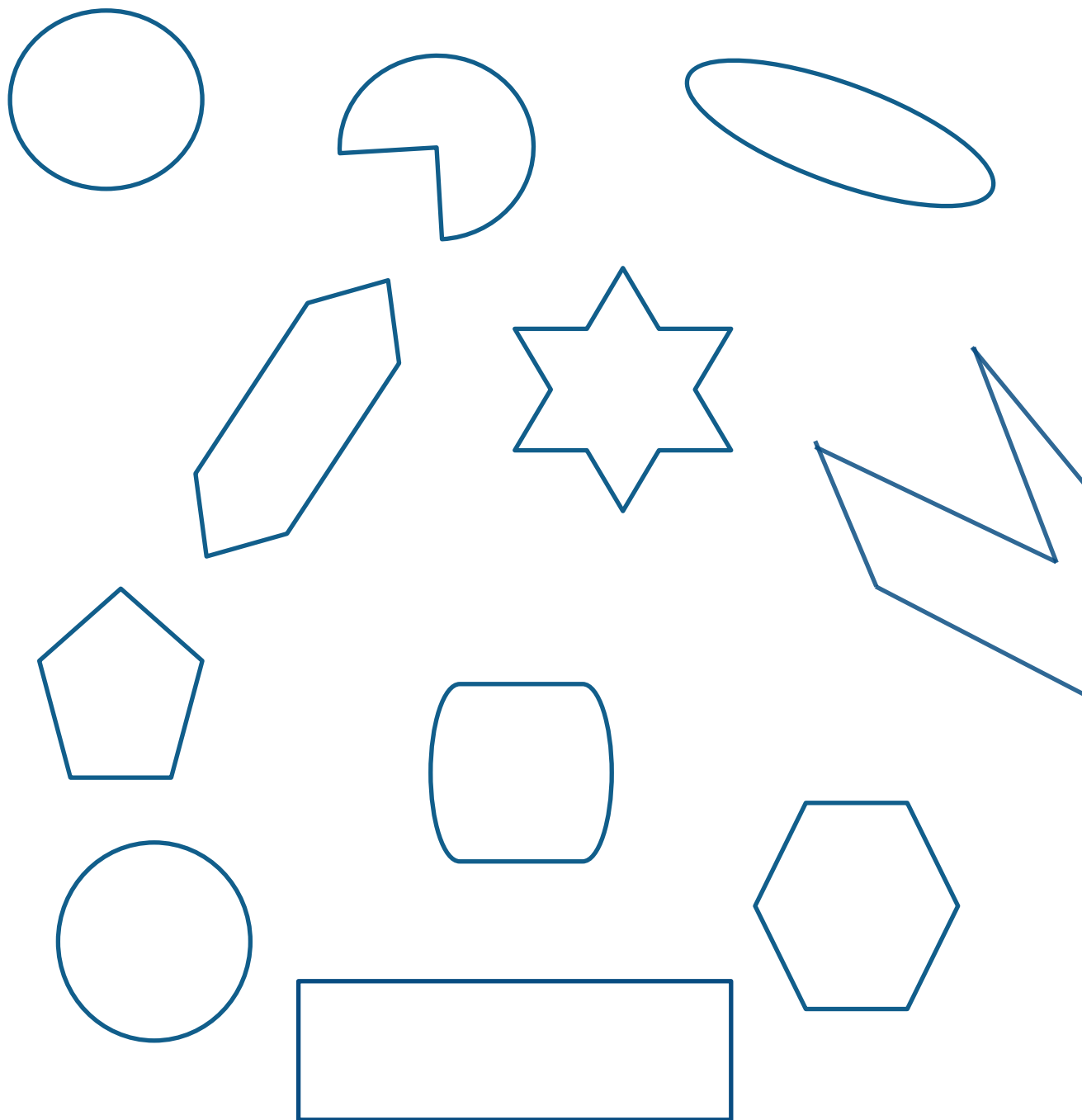

paper shapes

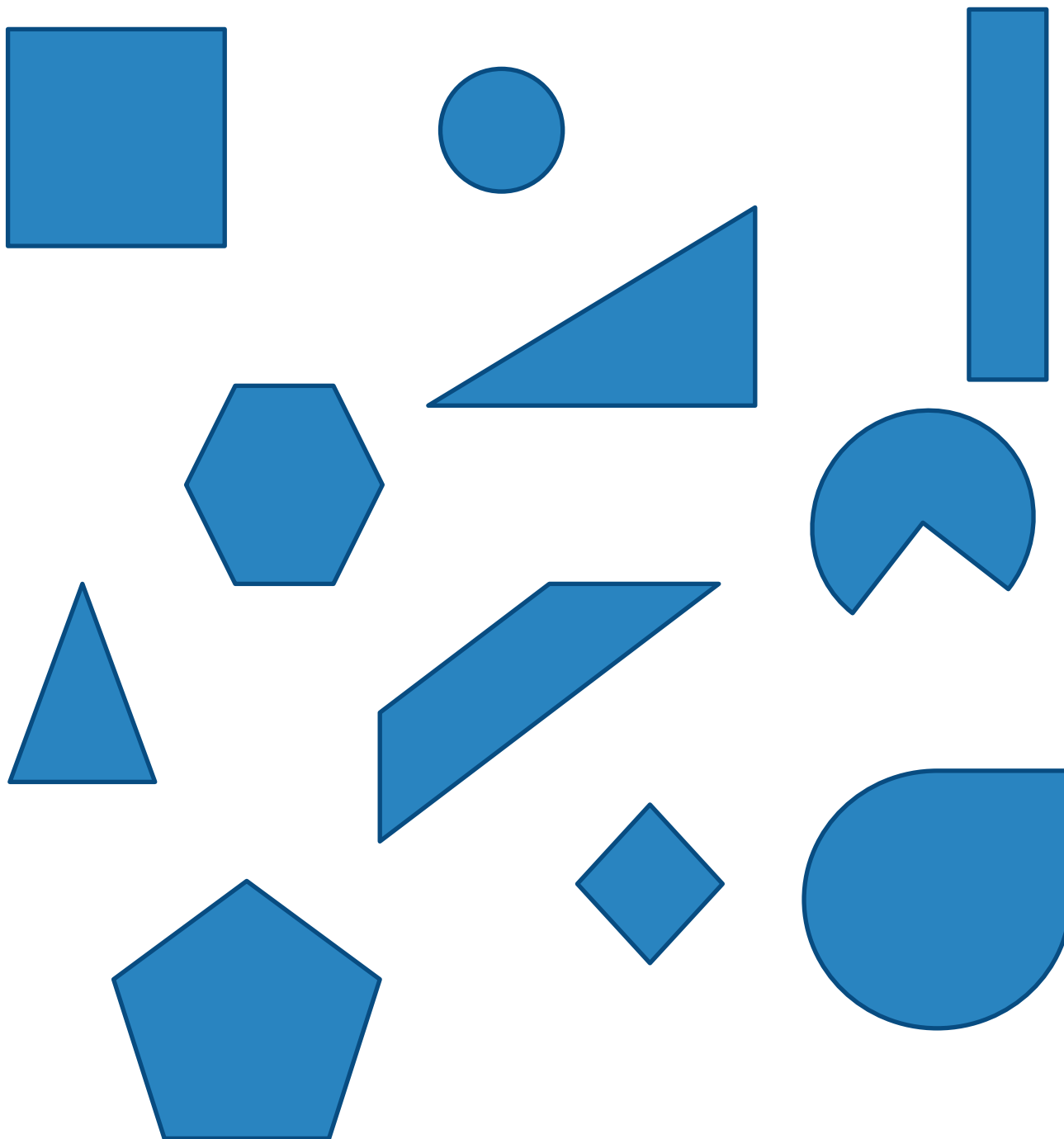

shapes

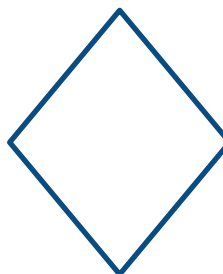
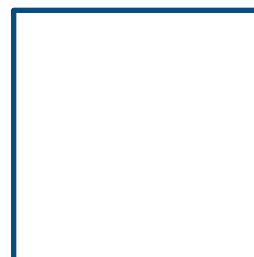
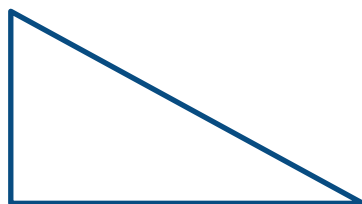
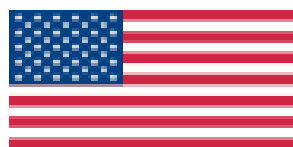
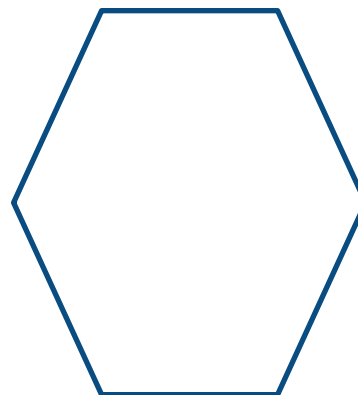
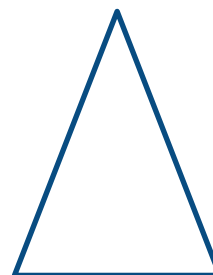
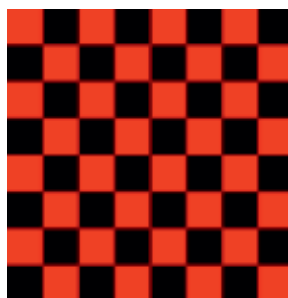
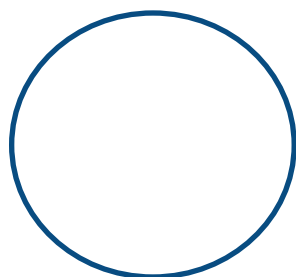

shapes

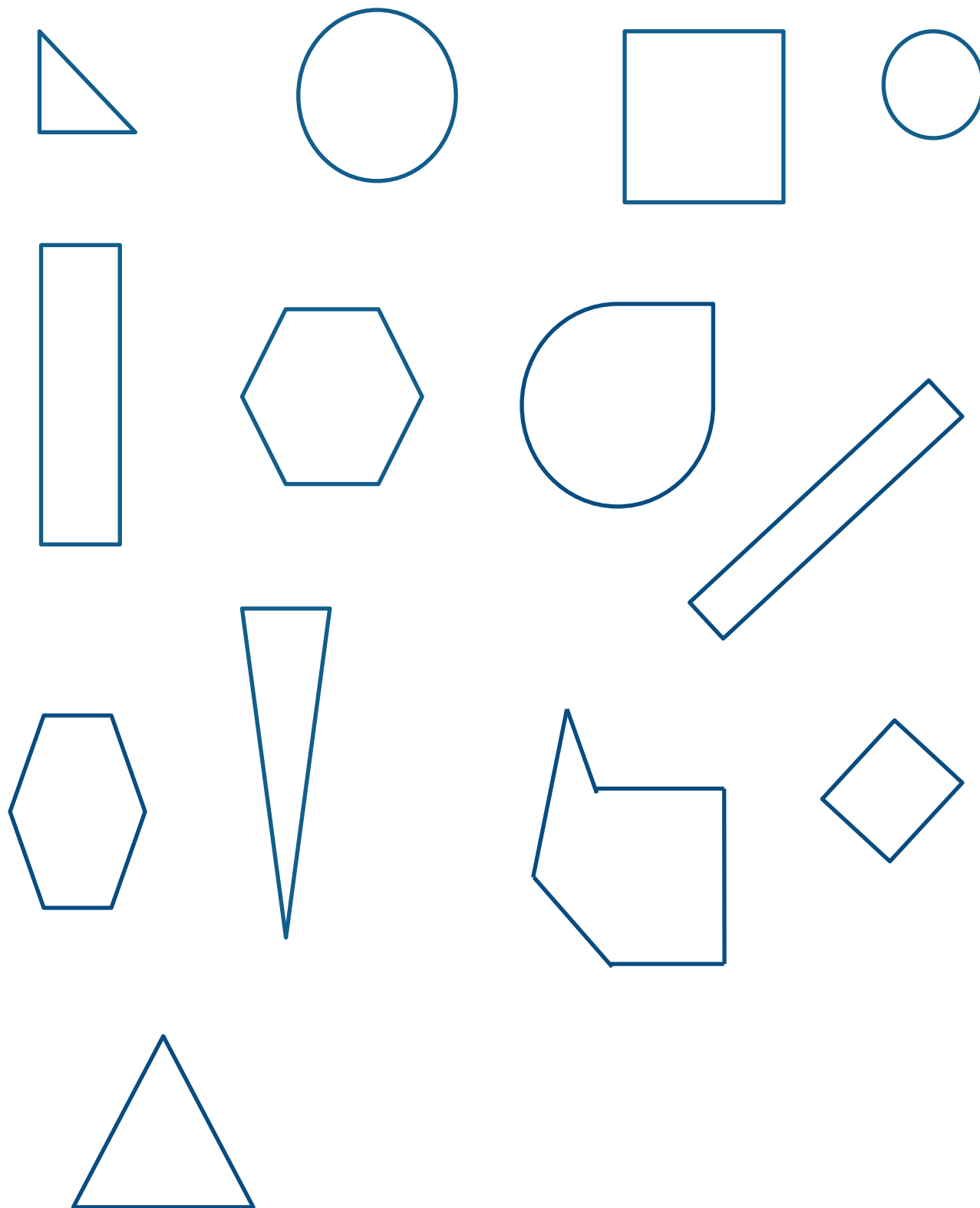

shapes

1	2	3	4	5	6	7	8	9	10
---	---	---	---	---	---	---	---	---	----

1	2	3	4	5	6	7	8	9	10
---	---	---	---	---	---	---	---	---	----

1	2	3	4	5	6	7	8	9	10
---	---	---	---	---	---	---	---	---	----

1	2	3	4	5	6	7	8	9	10
---	---	---	---	---	---	---	---	---	----

number path

Directions: Read to students.

Paste the sphere **above** the train.

Paste the cube **behind** the train.

Paste the cylinder **in front of** the train.

Paste the cone **below** the train.

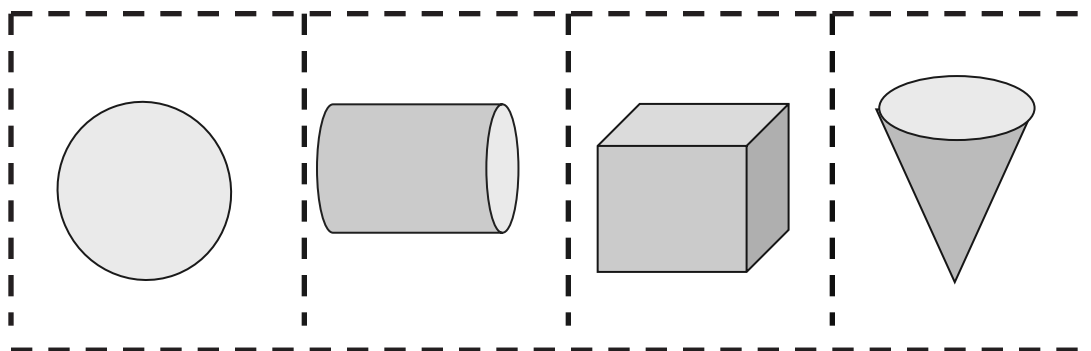

Provide one
strip for
every student.

